

December 2012

 No. OCH447
 REVISED EDITION-B

TECHNICAL & SERVICE MANUAL

Series PKFY Wall Mounted
R410A / R407C / R22

 Indoor unit
 [Model names]
 PKFY-P63VKM-E

[Service Ref.]

PKFY-P63VKM-E.TH
PKFY-P63VKM-ER1.TH

PKFY-P100VKM-E

PKFY-P100VKM-E.TH
PKFY-P100VKM-ER1.TH

Revision:

- PKFY-P63/100VKM-ER1.TH have been added in REVISED EDITION-B.
- Some descriptions have been modified.

- Please void OCH447 REVISED EDITION-A.

Note:

- This manual describes only service data of the indoor units.
- RoHS compliant products have <G> mark on the spec name plate.

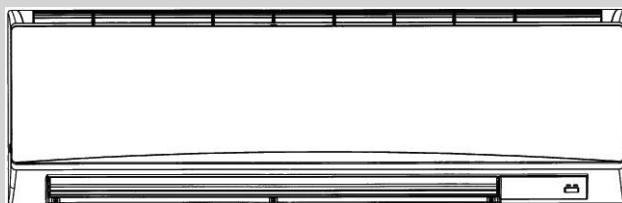

INDOOR UNIT

CONTENTS

1. TECHNICAL CHANGES	2
2. SAFETY PRECAUTION	2
3. PART NAMES AND FUNCTIONS	6
4. SPECIFICATION	14
5. OUTLINES AND DIMENSIONS	16
6. WIRING DIAGRAM	17
7. REFRIGERANT SYSTEM DIAGRAM	19
8. TROUBLESHOOTING	19
9. DISASSEMBLY PROCEDURE	27

PARTS CATALOG (OCB447)

1

TECHNICAL CHANGES

PKFY-P63VKM-E.TH → PKFY-P63VKM-ER1.TH
PKFY-P100VKM-E.TH → PKFY-P100VKM-ER1.TH

• INDOOR CONTROLLER BOARD (I.B.) has been changed. (S/W version up)

2

SAFETY PRECAUTION

CAUTIONS RELATED TO NEW REFRIGERANT

Cautions for units utilizing refrigerant R407C

Do not use the existing refrigerant piping.

The old refrigerant and lubricant in the existing piping contain a large amount of chlorine which may cause the lubricant deterioration of the new unit.

Use "low residual oil piping"

If there is a large amount of residual oil (hydraulic oil, etc.) inside the piping and joints, deterioration of the lubricant will result.

Store the piping indoors, and both ends of the piping sealed until just before brazing. (Leave elbow joints, etc. in their packaging.)

If dust, dirt, or water enters the refrigerant cycle, deterioration of the oil and compressor trouble may result.

Use ESTR, ETHER or HAB as the lubricant to coat flares and flange connection parts.

If large amount of mineral oil enters, that can cause deterioration of refrigerant oil etc.

Use liquid refrigerant to charge the system.

If gas refrigerant is used to seal the system, the composition of the refrigerant in the cylinder will change and performance may drop.

Do not use a refrigerant other than R407C.

If another refrigerant (R22, etc.) is used, the chlorine in the refrigerant may cause the lubricant deterioration.

Use a vacuum pump with a reverse flow check valve.

The vacuum pump oil may flow back into the refrigerant cycle and cause the lubricant deterioration.

Use the specified refrigerant only.

Never use any refrigerant other than that specified.

Doing so may cause a burst, an explosion, or fire when the unit is being used, serviced, or disposed of.

Correct refrigerant is specified in the manuals and on the spec labels provided with our products.

We will not be held responsible for mechanical failure, system malfunction, unit breakdown or accidents caused by failure to follow the instructions.

Ventilate the room if refrigerant leaks during operation. If refrigerant comes into contact with a flame, poisonous gases will be released.

[1] Cautions for service

- After recovering the all refrigerant in the unit, proceed to working.
- Do not release refrigerant in the air.
- After completing the repair service, recharge the cycle with the specified amount of liquid refrigerant.

[2] Refrigerant recharging

(1) Refrigerant recharging process

① Direct charging from the cylinder.

- R407C cylinder available on the market has a syphon pipe.
- Leave the syphon pipe cylinder standing and recharge it.
(By liquid refrigerant)

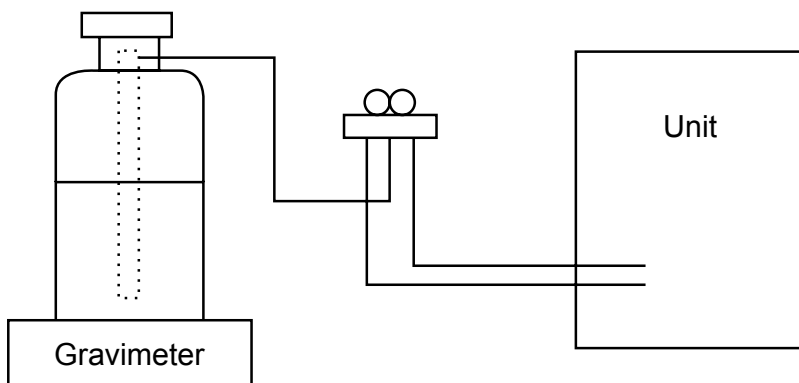

(2) Recharge in refrigerant leakage case

- After recovering the all refrigerant in the unit, proceed to working.
- Do not release the refrigerant in the air.
- After completing the repair service, recharge the cycle with the specified amount of liquid refrigerant.

[3] Service tools

Use the below service tools as exclusive tools for R407C refrigerant.

No.	Tool name	Specifications
①	Gauge manifold	<ul style="list-style-type: none"> · Only for R407C · Use the existing fitting SPECIFICATIONS. (UNF7/16) · Use high-tension side pressure of 3.43MPa·G or over.
②	Charge hose	<ul style="list-style-type: none"> · Only for R407C · Use pressure performance of 5.10MPa·G or over.
③	Electronic scale	—
④	Gas leak detector	· Use the detector for R134a or R407C.
⑤	Adaptor for reverse flow check	· Attach on vacuum pump.
⑥	Refrigerant charge base	—
⑦	Refrigerant cylinder	<ul style="list-style-type: none"> · For R407C · Top of cylinder (Brown) · Cylinder with syphon
⑧	Refrigerant recovery equipment	—

Cautions for units utilizing refrigerant R410A

Do not use the existing refrigerant piping.

The old refrigerant and lubricant in the existing piping contains a large amount of chlorine which may cause the lubricant deterioration of the new unit.

Use "low residual oil piping"

If there is a large amount of residual oil (hydraulic oil, etc.) inside the piping and joints, deterioration of the lubricant will result.

Store the piping indoors, and both ends of the piping sealed until just before brazing. (Leave elbow joints, etc. in their packaging.)

If dirt, dust or moisture enters into refrigerant cycle, that can cause deterioration of refrigerant oil or malfunction of compressor.

The refrigerant oil applied to flare and flange connections must be ester oil, ether oil or alkylbenzene oil in a small amount.

If large amount of mineral oil enters, that can cause deterioration of refrigerant oil etc.

Charge refrigerant from liquid phase of gas cylinder.

If the refrigerant is charged from gas phase, composition change may occur in refrigerant and the efficiency will be lowered.

Do not use refrigerant other than R410A.

If other refrigerant (R22 etc.) is used, chlorine in refrigerant can cause deterioration of refrigerant oil etc.

Use a vacuum pump with a reverse flow check valve.

Vacuum pump oil may flow back into refrigerant cycle and that can cause deterioration of refrigerant oil etc.

Use the following tools specifically designed for use with R410A refrigerant.

The following tools are necessary to use R410A refrigerant.

Tools for R410A	
Gauge manifold	Flare tool
Charge hose	Size adjustment gauge
Gas leak detector	Vacuum pump adaptor
Torque wrench	Electronic refrigerant charging scale

Handle tools with care.

If dirt, dust or moisture enters into refrigerant cycle, that can cause deterioration of refrigerant oil or malfunction of compressor.

Do not use a charging cylinder.

If a charging cylinder is used, the composition of refrigerant will change and the efficiency will be lowered.

Use the specified refrigerant only.

Never use any refrigerant other than that specified.

Doing so may cause a burst, an explosion, or fire when the unit is being used, serviced, or disposed of.

Correct refrigerant is specified in the manuals and on the spec labels provided with our products.

We will not be held responsible for mechanical failure, system malfunction, unit breakdown or accidents caused by failure to follow the instructions.

Ventilate the room if refrigerant leaks during operation. If refrigerant comes into contact with a flame, poisonous gases will be released.

[1] Cautions for service

- (1) Perform service after recovering the refrigerant left in unit completely.
- (2) Do not release refrigerant in the air.
- (3) After completing service, charge the cycle with specified amount of refrigerant.
- (4) When performing service, install a filter drier simultaneously.
Be sure to use a filter drier for new refrigerant.

[2] Additional refrigerant charge

When charging directly from cylinder

- Check that cylinder for R410A on the market is syphon type.
- Charging should be performed with the cylinder of syphon stood vertically. (Refrigerant is charged from liquid phase.)

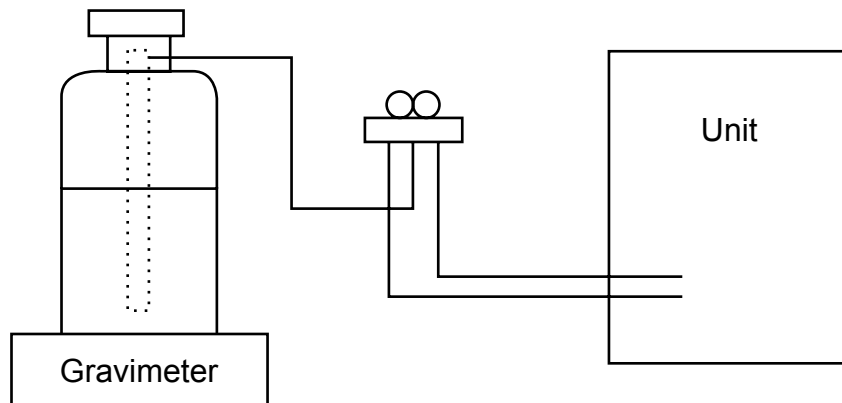

[3] Service tools

Use the below service tools as exclusive tools for R410A refrigerant.

No.	Tool name	Specifications
①	Gauge manifold	· Only for R410A
		· Use the existing fitting specifications. (UNF1/2)
		· Use high-tension side pressure of 5.3MPa·G or over.
②	Charge hose	· Only for R410A
		· Use pressure performance of 5.09MPa·G or over.
③	Electronic scale	—
④	Gas leak detector	· Use the detector for R134a, R407C or R410A.
⑤	Adaptor for reverse flow check	· Attach on vacuum pump.
⑥	Refrigerant charge base	—
⑦	Refrigerant cylinder	· Only for R410A · Top of cylinder (Pink)
		· Cylinder with syphon
⑧	Refrigerant recovery equipment	—

3-1. Indoor unit

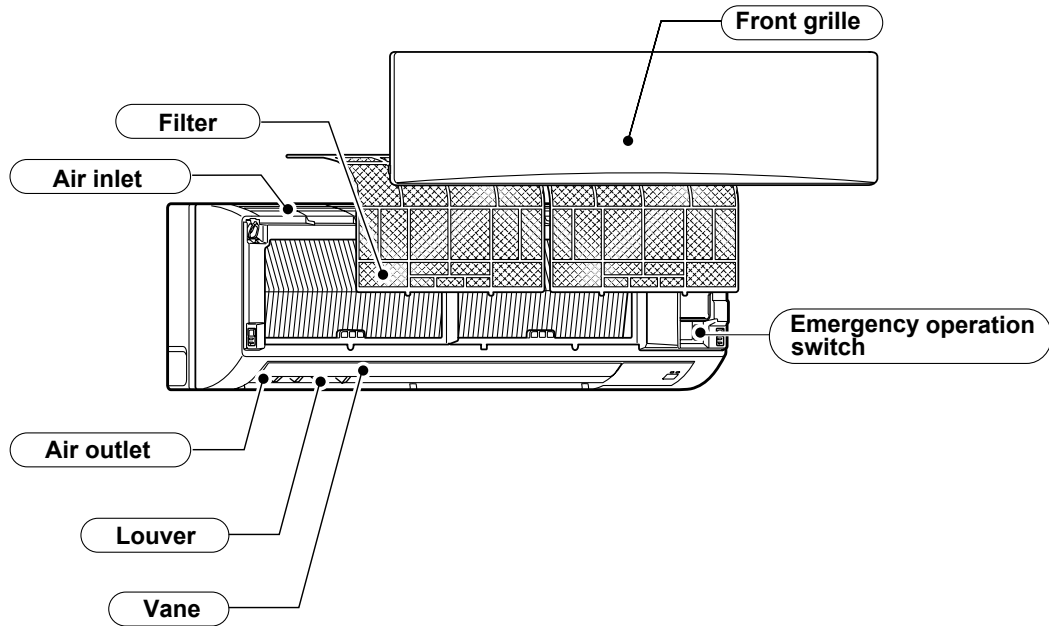

3-2. WIRED REMOTE CONTROLLER <PAR-30MAA/PAR-31MAA>

Wired remote controller function

* The functions which can be used are restricted according to the model.

○ : Supported ✕ : Unsupported

	Function	PAR-30MAA/PAR-31MAA		PAR-21MAA
		Slim	City multi	
Body	Product size H × W × D (mm)	120 × 120 × 19		120 × 130 × 19
	LCD	Full Dot LCD		Partial Dot LCD
	Backlight	○		✕
Energy-saving	Energy-saving operation schedule	○	✕	✕
	Automatic return to the preset temperature	○		✕
Restriction	Setting the temperature range restriction	○		○
Function	Operation lock function	○		○
	Weekly timer	○		✕
	On / Off timer	○		○
	High Power	○	✕	✕
	Manual vane angle	○		○

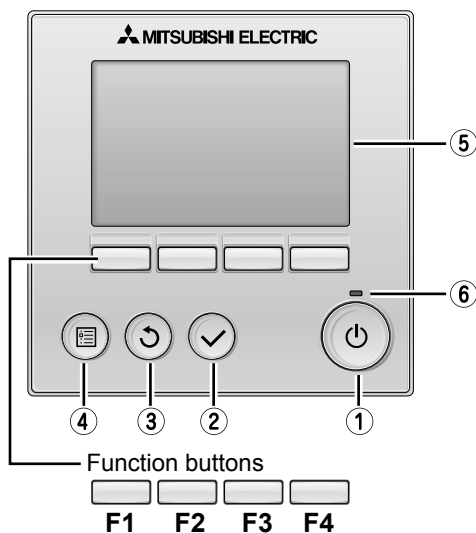

① ON / OFF button

Press to turn ON/OFF the indoor unit.

② SELECT button

Press to save the setting.

③ RETURN button

Press to return to the previous screen.

④ MENU button

Press to bring up the Main menu.

⑤ Backlit LCD

Operation settings will appear.
When the backlight is off, pressing any button turns the backlight on and it will stay lit for a certain period of time depending on the screen.

When the backlight is off, pressing any button turns the backlight on and does not perform its function. (except for the (ON / OFF) button)

The functions of the function buttons change depending on the screen. Refer to the button function guide that appears at the bottom of the LCD for the functions they serve on a given screen.

When the system is centrally controlled, the button function guide that corresponds to the locked button will not appear.

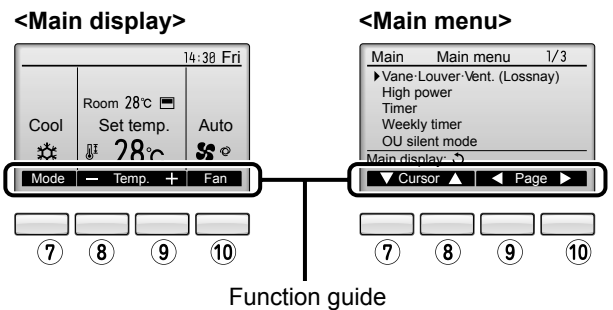

⑥ ON / OFF lamp

This lamp lights up in green while the unit is in operation. It blinks while the remote controller is starting up or when there is an error.

⑦ Function button F1

Main display : Press to change the operation mode.
Main menu : Press to move the cursor down.

⑧ Function button F2

Main display : Press to decrease temperature.
Main menu : Press to move the cursor up.

⑨ Function button F3

Main display : Press to increase temperature.
Main menu : Press to go to the previous page.

⑩ Function button F4

Main display : Press to change the fan speed.
Main menu : Press to go to the next page.

The main display can be displayed in two different modes: "Full" and "Basic".

The factory setting is "Full". To switch to the "Basic" mode, change the setting on the Main display setting.

<Full mode>

* All icons are displayed for explanation.

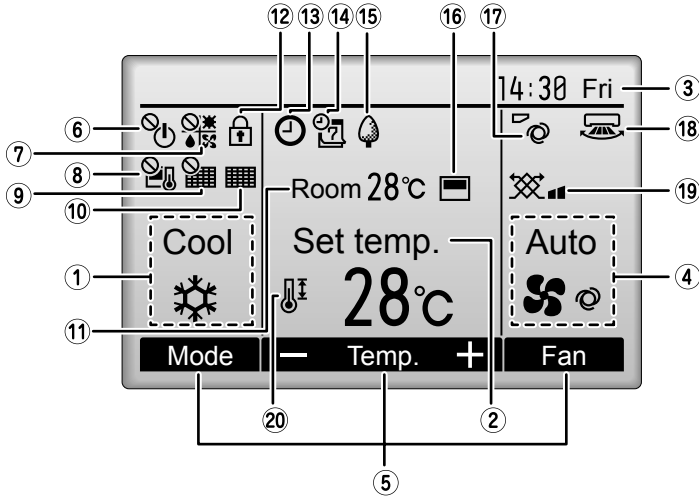

<Basic mode>

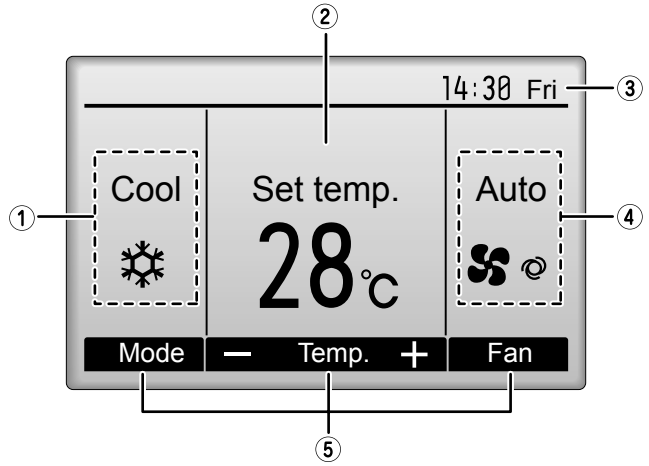

① Operation mode

Indoor unit operation mode appears here.

② Preset temperature

Preset temperature appears here.

③ Clock (See the Installation Manual.)

Current time appears here.

④ Fan speed

Fan speed setting appears here.

⑤ Button function guide

Functions of the corresponding buttons appear here.



Appears when the ON/OFF operation is centrally controlled.



Appears when the operation mode is centrally controlled.



Appears when the preset temperature is centrally controlled.



Appears when the filter reset function is centrally controlled.



Indicates when filter needs maintenance.

⑪ Room temperature (See the Installation Manual.)

Current room temperature appears here.



Appears when the buttons are locked.



Appears when the On/Off timer or Night setback function is enabled.



Appears when the Weekly timer is enabled.



Appears while the units are operated in the energy-save mode.



Appears when the built-in thermistor on the remote controller is activated to monitor the room temperature (a).
 appears when the thermistor on the indoor unit is activated to monitor the room temperature.



Indicates the vane setting.



Indicates the louver setting.



Indicates the ventilation setting.



Appears when the preset temperature range is restricted.

Most settings (except ON / OFF, mode, fan speed, temperature) can be made from the Menu screen.



Menu structure

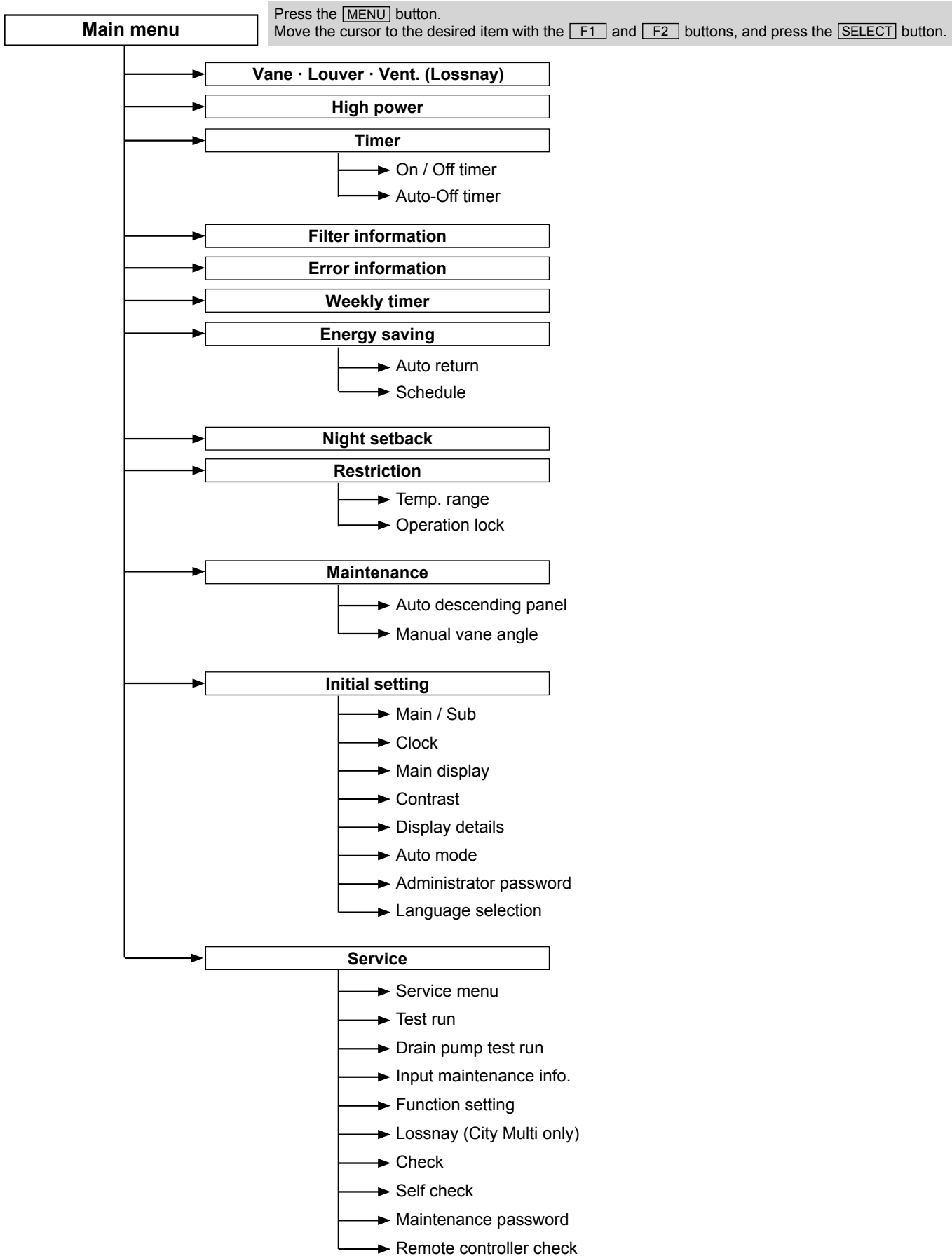

Not all functions are available on all models of indoor units.

Main menu list

Setting and display items		Setting details
Vane · Louver · Vent. (Lossnay)		<p>Use to set the vane angle.</p> <ul style="list-style-type: none"> • Select a desired vane setting from five different settings. <p>Use to turn ON / OFF the louver.</p> <ul style="list-style-type: none"> • Select a desired setting from "ON" and "OFF." <p>Use to set the amount of ventilation.</p> <ul style="list-style-type: none"> • Select a desired setting from "Off," "Low," and "High."
High power		<p>Use to reach the comfortable room temperature quickly.</p> <ul style="list-style-type: none"> • Units can be operated in the High-power mode for up to 30 minutes.
Timer	On/Off timer	<p>Use to set the operation On/Off times.</p> <ul style="list-style-type: none"> • Time can be set in 5-minute increments. * Clock setting is required.
	Auto-Off timer	<p>Use to set the Auto-Off time.</p> <ul style="list-style-type: none"> • Time can be set to a value from 30 to 240 in 10-minute increments.
Filter information		<p>Use to check the filter status.</p> <ul style="list-style-type: none"> • The filter sign can be reset.
Error information		<p>Use to check error information when an error occurs.</p> <ul style="list-style-type: none"> • Error code, error source, refrigerant address, unit model, manufacturing number, contact information (dealer's phone number) can be displayed. * The unit model, manufacturing number, and contact information need to be registered in advance to be displayed.
Weekly timer		<p>Use to set the weekly operation On / Off times.</p> <ul style="list-style-type: none"> • Up to eight operation patterns can be set for each day. * Clock setting is required. * Not valid when the On/Off timer is enabled.
Energy saving	Auto return	<p>Use to get the units to operate at the preset temperature after performing energy-save operation for a specified time period.</p> <ul style="list-style-type: none"> • Time can be set to a value from 30 and 120 in 10-minute increments. * This function will not be valid when the preset temperature ranges are restricted.
	Schedule	<p>Set the start/stop times to operate the units in the energy-save mode for each day of the week, and set the energy-saving rate.</p> <ul style="list-style-type: none"> • Up to four energy-save operation patterns can be set for each day. • Time can be set in 5-minute increments. • Energy-saving rate can be set to a value from 0% or 50 to 90% in 10% increments. * Clock setting is required.
Night setback		<p>Use to make Night setback settings.</p> <ul style="list-style-type: none"> • Select "Yes" to enable the setting, and "No" to disable the setting. The temperature range and the start/stop times can be set. * Clock setting is required.
Restriction	Temp. range	<p>Use to restrict the preset temperature range.</p> <ul style="list-style-type: none"> • Different temperature ranges can be set for different operation modes.
	Operation lock	<p>Use to lock selected functions.</p> <ul style="list-style-type: none"> • The locked functions cannot be operated.
Maintenance	Auto descending panel	<p>Auto descending panel (Optional parts) Up / Down you can do.</p>
	Manual vane angle	<p>Use to set the vane angle for each vane to a fixed position.</p>
Initial setting	Main/Sub	<p>When connecting two remote controllers, one of them needs to be designated as a sub controller.</p>
	Clock	<p>Use to set the current time.</p>
	Main display	<p>Use to switch between "Full" and "Basic" modes for the Main display.</p> <ul style="list-style-type: none"> • The default setting is "Full."
	Contrast	<p>Use to adjust screen contrast.</p>



Setting and display items		Setting details
Initial setting	Display details	<p>Make the settings for the remote controller related items as necessary.</p> <p>Clock: The factory settings are "Yes" and "24h" format.</p> <p>Temperature: Set either Celsius (°C) or Fahrenheit (°F).</p> <p>Room temp. : Set Show or Hide.</p> <p>Auto mode: Set the Auto mode display or Only Auto display.</p>
	Auto mode	<p>Whether or not to use the AUTO mode can be selected by using the button.</p> <p>This setting is valid only when indoor units with the AUTO mode function are connected.</p>
	Administrator password	<p>The administrator password is required to make the settings for the following items.</p> <ul style="list-style-type: none"> • Timer setting • Energy-save setting • Weekly timer setting • Restriction setting • Outdoor unit silent mode setting • Night set back
	Language selection	<p>Use to select the desired language.</p>
Service	Test run	<p>Select "Test run" from the Service menu to bring up the Test run menu.</p> <ul style="list-style-type: none"> • Test run • Drain pump test run
	Input maintenance	<p>Select "Input maintenance Info." from the Service menu to bring up the Maintenance information screen.</p> <p>The following settings can be made from the Maintenance Information screen.</p> <ul style="list-style-type: none"> • Model name input • Serial No. input • Dealer information input
	Function setting	<p>Make the settings for the indoor unit functions via the remote controller as necessary.</p>
	LOSSNAY setting (City Multi only)	<p>This setting is required only when the operation of City Multi units is interlocked with LOSSNAY units.</p>
	Check	<p>Error history: Display the error history and execute delete error history.</p> <p>Refrigerant leak check: Refrigerant leaks can be judged.</p> <p>Smooth maintenance: The indoor and outdoor maintenance data can be displayed.</p> <p>Request cord: Details of the operation data including each thermistor temperature and error history can be checked.</p>
	Self check	<p>Error history of each unit can be checked via the remote controller.</p>
	Maintenance password	<p>Take the following steps to change the maintenance password.</p>
	Remote controller check	<p>When the remote controller does not work properly, use the remote controller checking function to troubleshoot the problem.</p>

3-3. WIRED REMOTE CONTROLLER <PAR-21MAA>

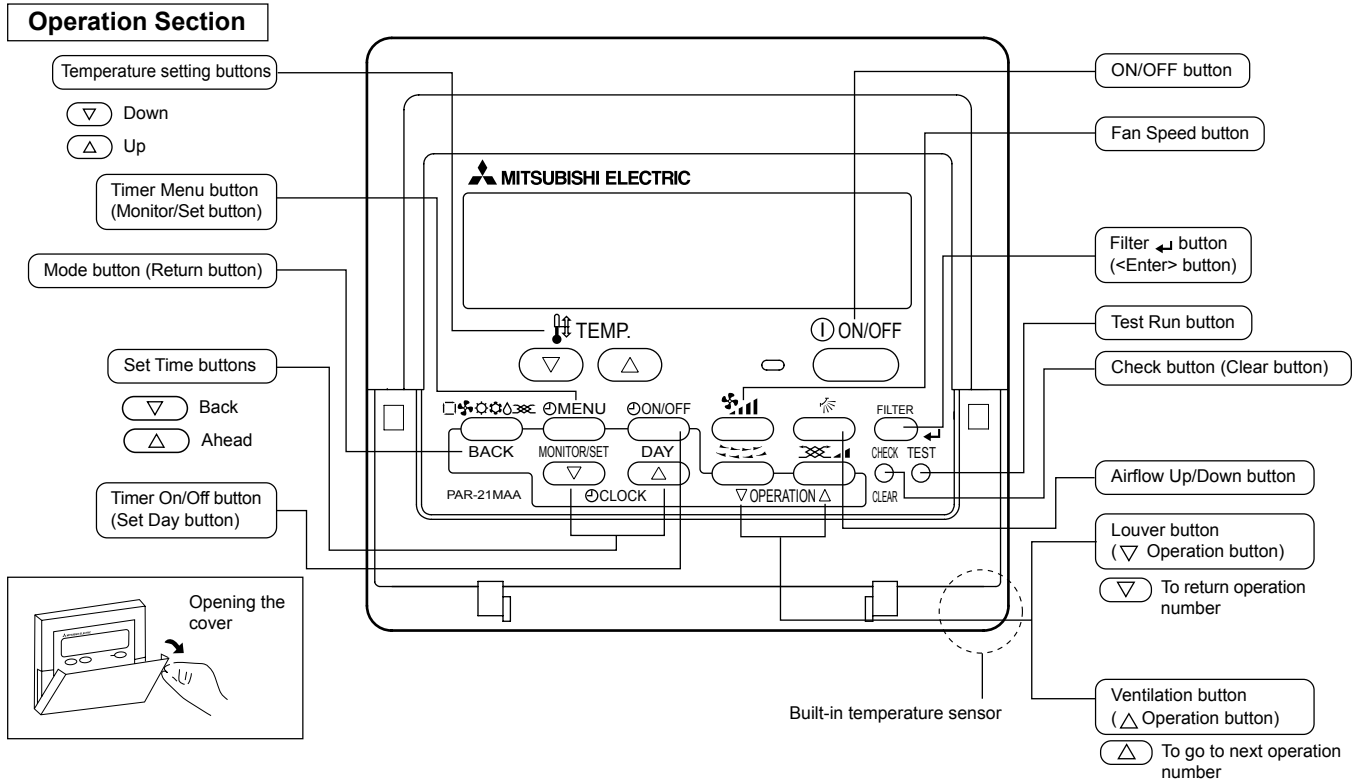
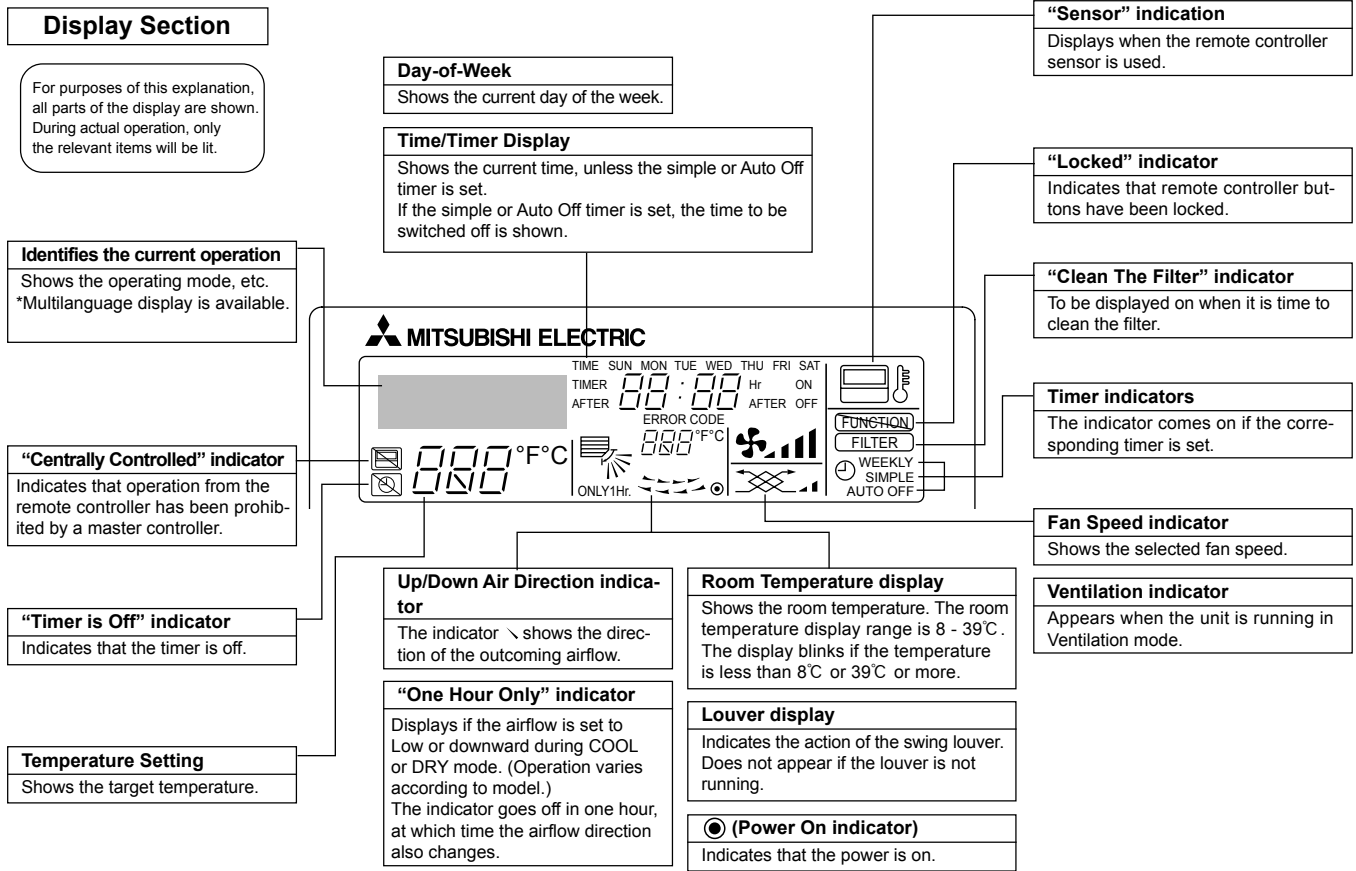

Note:

- “PLEASE WAIT” message
This message is displayed for approximately 3 minutes when power is supplied to the indoor unit or when the unit is recovering from a power failure.
- “NOT AVAILABLE” message
This message is displayed if an invalid button is pressed (to operate a function that the indoor unit does not have).
If a single remote controller is used to operate multiple indoor units simultaneously that are different types, this message will not be displayed as far as any of the indoor units is equipped with the function.

3-4. Wireless remote controller

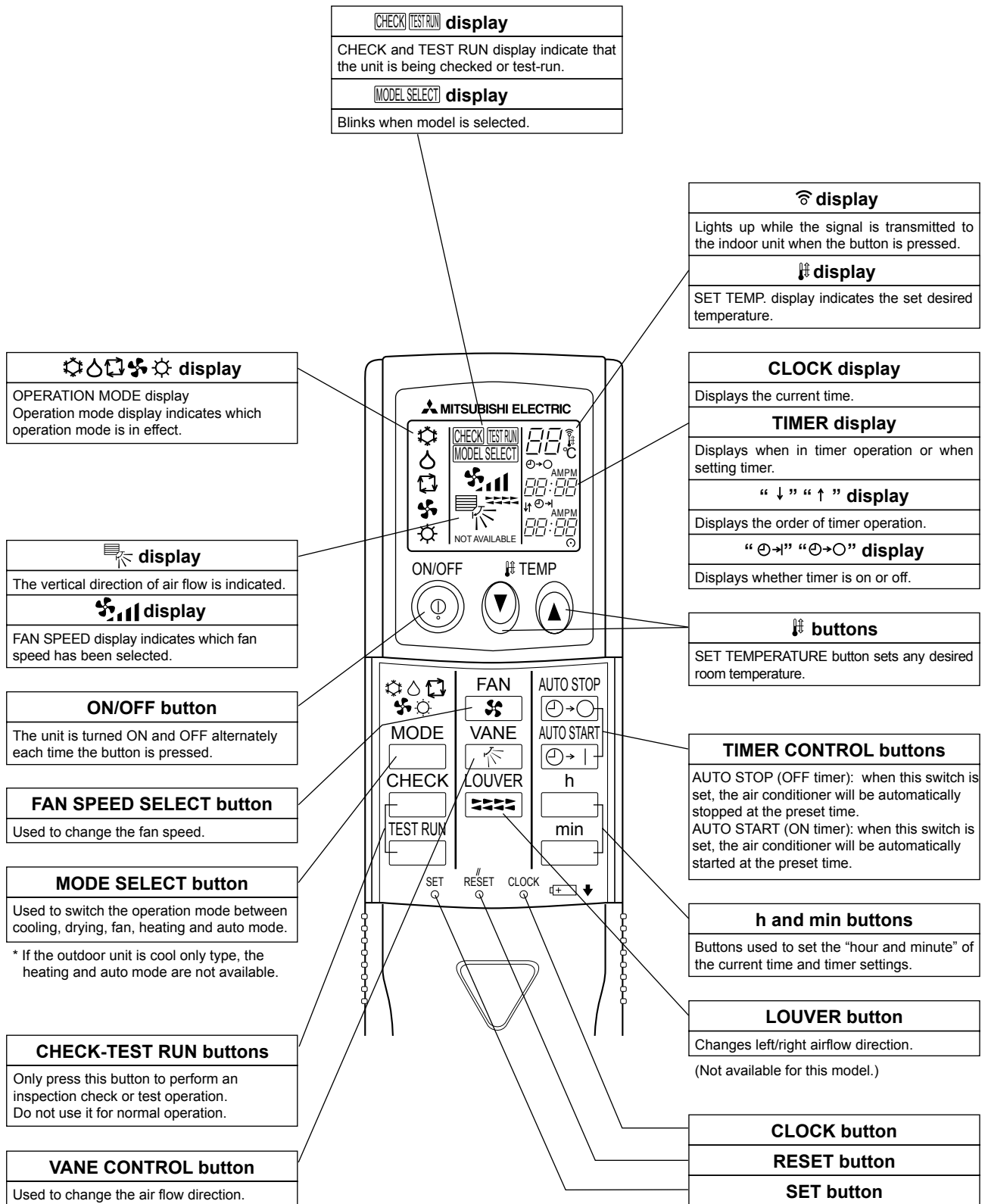

4-1. Specifications

Model		PKFY-P63VKM-E		PKFY-P100VKM-E	
Power source		1-phase 220-240V 50Hz, 1-phase 220V 60Hz			
Cooling capacity (Nominal)	*1	kW	7.1	11.2	
	*1	kcal/h	6,100	9,600	
	*1	Btu/h	24,200	38,200	
	*2	kcal/h	6,300	10,000	
	*4	kW	0.05	0.08	
	*4	A	0.37	0.58	
Heating capacity (Nominal)	*3	kW	8.0	12.5	
	*3	kcal/h	6,900	10,800	
	*3	Btu/h	27,300	42,600	
		kW	0.04	0.07	
		A	0.30	0.51	
External finish		Plastic, MUNSELL (1.0Y 9.2/0.2)			
External dimension H × W × D		mm	365 × 1170 × 295		
		in.	14-3/8" × 46-1/16" × 11-5/8"		
Net weight		kg (lb)	21 (46)		
Heat exchanger		Cross fin (Aluminum fin and copper tube)			
Fan	Type x Quantity		Line flow fan × 1		
	External static press.	Pa	0		
		mmH ₂ O	0		
	Motor type		DC motor		
	Motor output		0.056		
	Driving mechanism		Direct-drive		
	Airflow rate (Low-High)	m ³ /min	16 - 20	20 - 26	
		L/s	267 - 333	333 - 433	
cfm		565 - 706	706 - 918		
Noise level (Low-High) (measured in anechoic room)		dB <A>	39 - 45	41 - 49	
Insulation material		Polyethylene sheet			
Air filter		PP honeycomb			
Protection device		Fuse			
Refrigerant control device		LEV			
Connectable outdoor unit		R410A, R407C, R22 CITY MULTI			
Diameter of refrigerant pipe	Liquid (R410A)	mm (in.)	ø9.52 (ø3/8") Flare	ø9.52 (ø3/8") Flare	
			ø9.52 (ø3/8") Flare	ø9.52 (ø3/8") Flare	
	Gas (R410A)	mm (in.)	ø15.88 (ø5/8") Flare	ø15.88 (ø5/8") Flare	
			ø15.88 (ø5/8") Flare	ø19.05 (ø5/8") Flare	
Field drain pipe size		mm (in.)	I.D. 16mm (5/8")		
Standard attachment	Document	Installation Manual, Instruction Book			
Optional parts	Accessory	PAC-SH94DM-E			
Remark					
Installation		Details on foundation work, insulation work, electrical wiring, power source switch, and other items shall be referred to the Installation Manual.			
Note :		*1 Nominal cooling conditions	*2 Nominal cooling conditions	*3 Nominal heating conditions	Unit converter
Indoor :		27°CDB/19°CWB (81°FDB/66°FWB)	27°CDB/19.5°CWB (81°FDB/67°FWB)	20°CDB (68°FDB)	kcal/h = kW × 860
Outdoor :		35°CDB (95°FDB)	35°CDB (95°FDB)	7°CDB/6°CWB (45°FDB/43°FWB)	Btu/h = kW × 3,412
Pipe length :		7.5 m (24-9/16 ft)	5 m (16-3/8 ft)	7.5 m (24-9/16 ft)	cfm = m ³ /min × 35.31
Level difference :		0 m (0 ft)	0 m (0 ft)	0 m (0 ft)	lb = kg/0.4536
*4 Electrical characteristic of cooling are included optional drain - pump.					*Above specification data is subject to rounding variation.
* Nominal conditions *1, *3 are subject to JIS B8615-1.					
* Due to continuing improvement, above specification may be subject to change without notice.					



4-2. Electrical parts specifications

Service Ref. Parts name	Symbol	PKFY-P63VKM-E.TH PKFY-P63VKM-ER1.TH	PKFY-P100VKM-E.TH PKFY-P100VKM-ER1.TH
Room temperature thermistor	TH21	Resistance 0°C/15kΩ, 10°C/9.6kΩ, 20°C/6.3kΩ, 25°C/5.4kΩ, 30°C/4.3kΩ, 40°C/3.0kΩ	
Liquid pipe thermistor	TH22	Resistance 0°C/15kΩ, 10°C/9.6kΩ, 20°C/6.3kΩ, 25°C/5.4kΩ, 30°C/4.3kΩ, 40°C/3.0kΩ	
Gas pipe thermistor	TH23 TH24	Resistance 0°C/15kΩ, 10°C/9.6kΩ, 20°C/6.3kΩ, 25°C/5.4kΩ, 30°C/4.3kΩ, 40°C/3.0kΩ	
Fuse (Indoor controller board)	FUSE	250V 3.15A	
Fan motor	MF	8-Pole Output 56W / RCOJ56-AC	
Vane motor	MV	MSBPC20 DC12V	
Linear expansion valve	LEV	EFM-40YGME DC 12 V	EFM-80YGME DC 12 V
Power supply terminal block	TB2	(L, N, ⊕) 250V 20A	
Transmission terminal block	TB5	(M1, M2, S) 250V 20A	
MA remote controller terminal block	TB15	(1, 2) 250V 10A	

4-3. Sound levels

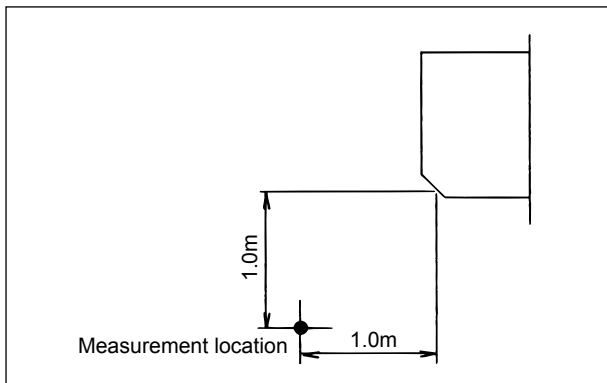

Sound level at anechoic room : Low-High

	Sound level dB (A)
PKFY-P63VKM-E.TH PKFY-P63VKM-ER1.TH	39 - 45
PKFY-P100VKM-E.TH PKFY-P100VKM-ER1.TH	41 - 49

* Measured in anechoic room.

4-4. NC curves

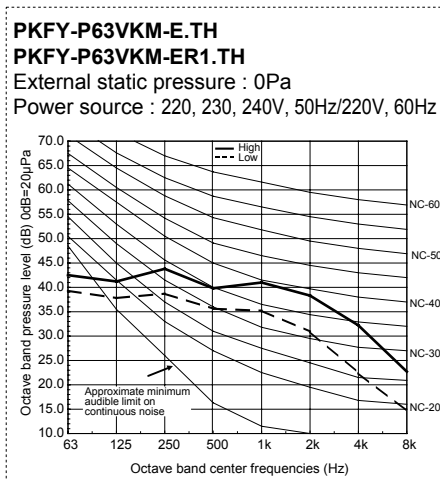

OCH447B

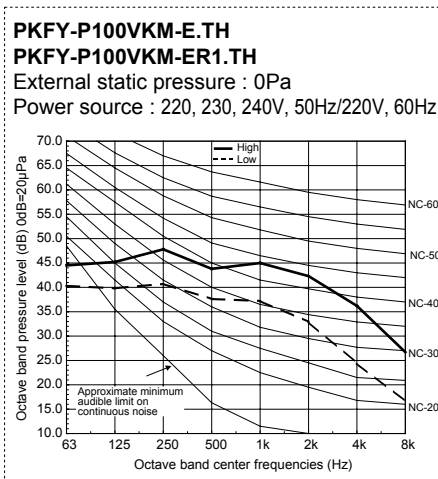

PKFY-P63VKM-E.TH
PKFY-P63VKM-ER1.TH

PKYF-P100VKM-E.TH
PKFY-P100VKM-ER1.TH

Unit : mm

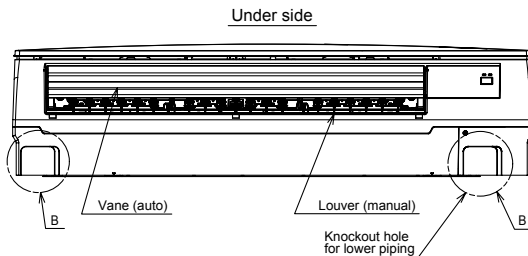
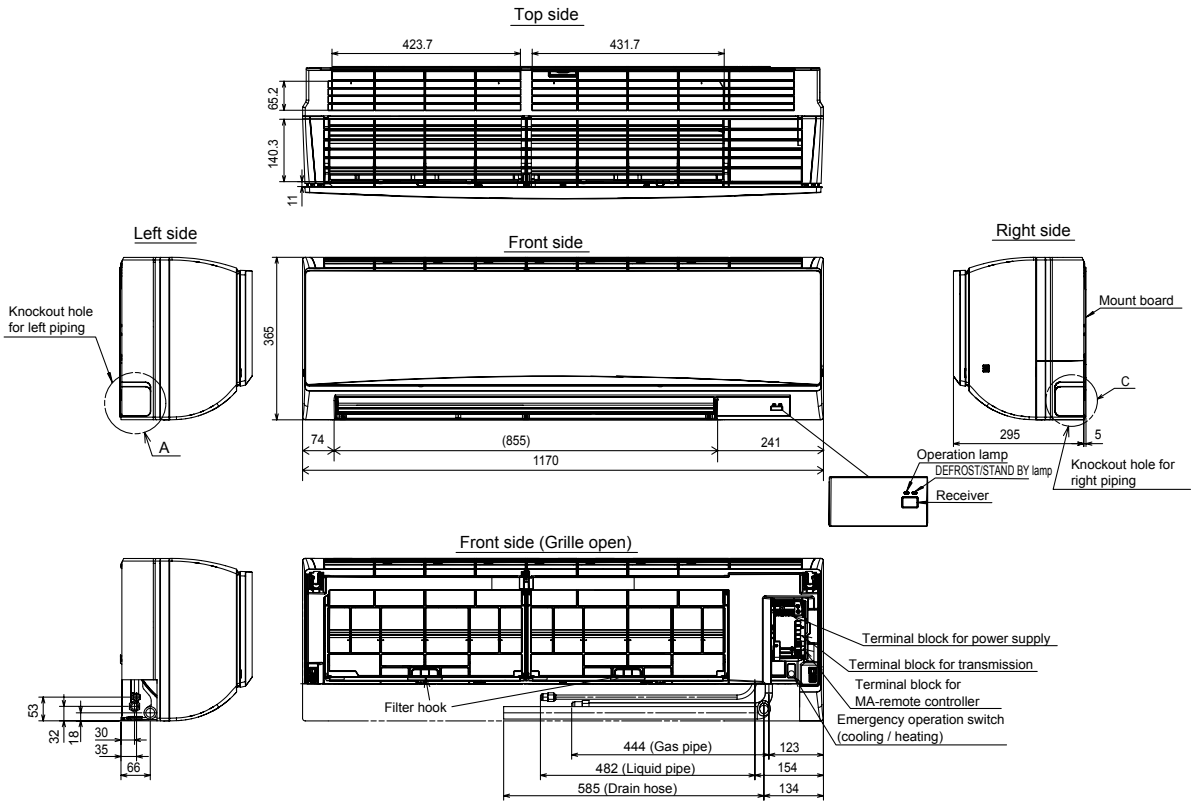

Piping connection department

① Liquid pipe	Refrigerant pipe : $\phi 9.52$ Flared connection : 3/8F
② Gas pipe	Refrigerant pipe : $\phi 15.88$ Flared connection : 5/8F
③ Drain hose	$\phi 16$ O.D

Sleeve (purchased locally)	Through hole
$\phi 75$	$\phi 75\text{--}\phi 80$

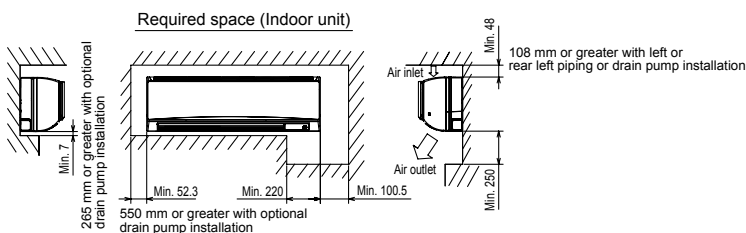
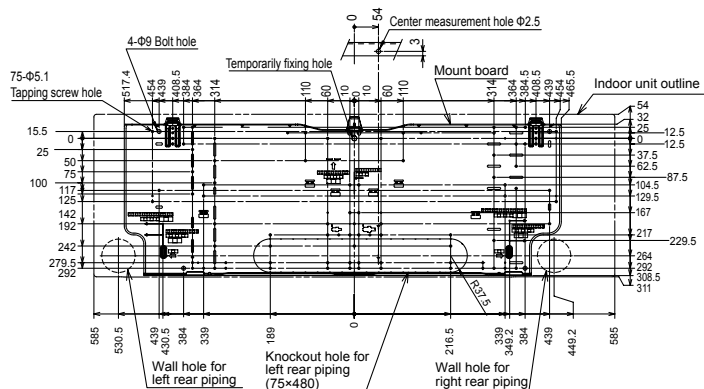
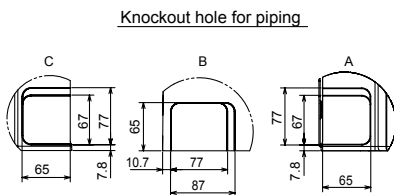

PKFY-P63VKM-E.TH

PKYF-P100VKM-E.TH

SYMBOL	NAME	SYMBOL	NAME
I.B	INDOOR CONTROLLER BOARD	TH21	THERMISTOR ROOM TEMP. DETECTION (0°C/15kΩ, 25°C/5.4kΩ)
CN32	CONNECTOR REMOTE SWITCH	TH22	PIPE TEMP. DETECTION/LIQUID (0°C/15kΩ, 25°C/5.4kΩ)
CN51	CENTRALLY CONTROL	TH23	PIPE TEMP. DETECTION/GAS1 (0°C/15kΩ, 25°C/5.4kΩ)
CN52	REMOTE INDICATION	TH24	PIPE TEMP. DETECTION/GAS2 (0°C/15kΩ, 25°C/5.4kΩ)
BZ	BUZZER	A.B	ADDRESS BOARD
DSA	SURGE ABSORBER	SWA	SWITCH FAN SPEED SELECTOR
FUSE	FUSE (T3.15AL 250V)	SW1	MODE SELECTION
LED1	POWER SUPPLY (I.B)	SW11	ADDRESS SETTING 1s DIGIT
LED2	POWER SUPPLY (I.B)	SW12	ADDRESS SETTING 10ths DIGIT
SW2	SWITCH CAPACITY CODE	SW14	BRANCH No.
SW3	MODE SELECTION	S.B	SWITCH BOARD
SW4	MODEL SELECTOR	SWE1	EMERGENCY OPERATION (HEAT)
SWE	DRAIN PUMP (TEST MODE)	SWE2	EMERGENCY OPERATION (COOL)
X1	AUX.RELAY DRAIN PUMP (OPTION)	W.B	PCB FOR WIRELESS REMOTE CONTROLLER
MOV 01.02	VARISTOR	LED1	LED (OPERATION INDICATOR: GREEN)
LEV	LINEAR EXPANSION VALVE	LED2	LED (OPERATION FOR HEATING: ORANGE)
MF	FAN MOTOR	RU	RECEIVING UNIT
MV	VANE MOTOR	DP	DRAIN PUMP (OPTION)
TB2	TERMINAL POWER SUPPLY	FS	DRAIN FLOAT SWITCH (OPTION)
TB5	BLOCK TRANSMISSION		
TB15	MA-REMOTE CONTROLLER		

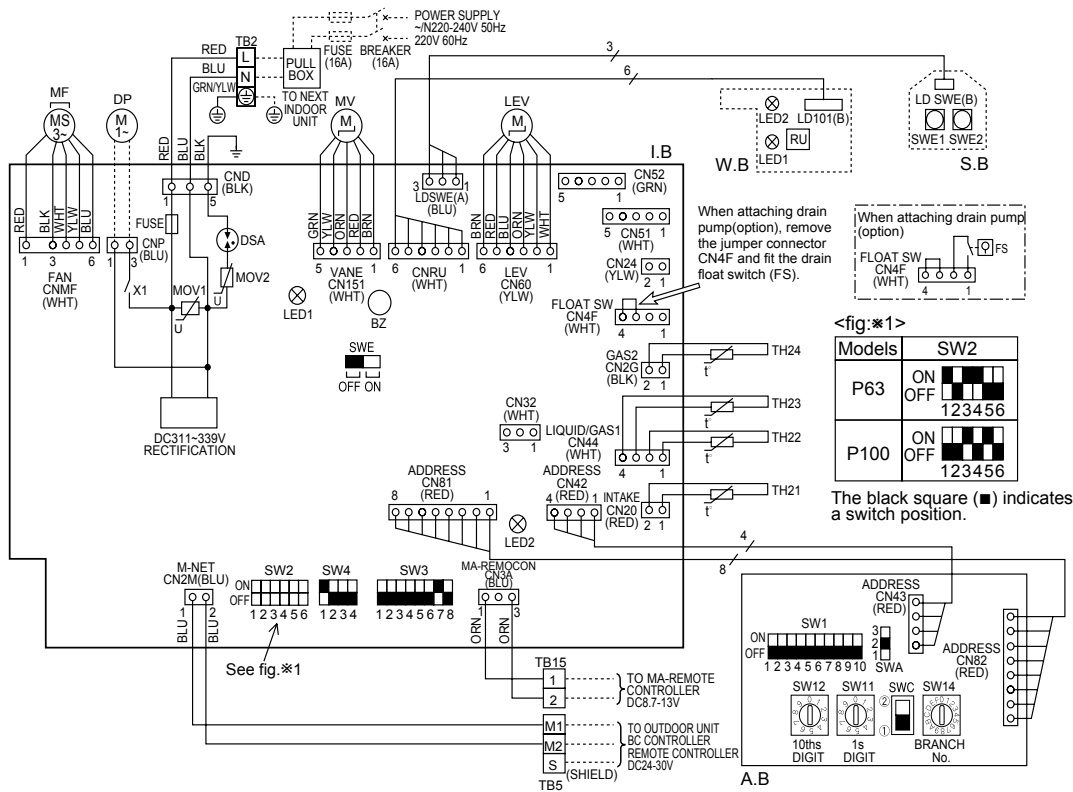

LED on indoor board for service

Mark	Meaning	Function
LED1	Main power supply	Main power supply (Indoor unit:220-240V) Power on → lamp is lit
LED2	Power supply for MA-Remote controller	Power supply for MA-Remote controller on → lamp is lit

NOTES:

- At servicing for outdoor unit, always follow the wiring diagram of outdoor unit.
- In case of using MA-Remote controller, please connect to TB15.
(Remote controller wire is non-polar.)
- In case of using M-NET, please connect to TB5. (Transmission line is non-polar.)
- Symbol [S] of TB5 is the shield wire connection.
- Symbols used in wiring diagram above are, [] : terminal block, [] : connector.
- The setting of the SW2 dip switches differs in the capacity. For the detail, refer to fig.*1.

7

REFRIGERANT SYSTEM DIAGRAM

PKFY-P63VKM-E.TH
PKFY-P63VKM-ER1.TH

PKYF-P100VKM-E.TH
PKFY-P100VKM-ER1.TH

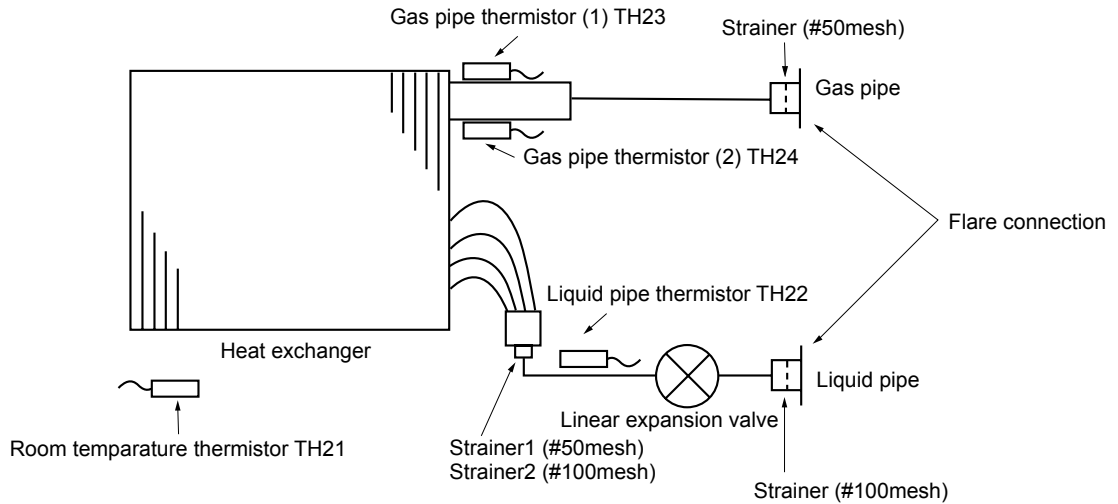

Unit : mm (inch)

Model	PKFY-P63VKM-E	PKFY-P100VKM-E
Gas pipe	φ15.88 (5/8)	φ15.88 (5/8)
Liquid pipe	φ9.52 (3/8)	φ9.52 (3/8)

8

TROUBLESHOOTING

8-1. HOW TO CHECK THE PARTS

PKFY-P63VKM-E.TH PKYF-P100VKM-E.TH
PKFY-P63VKM-ER1.TH PKFY-P100VKM-ER1.TH

Parts name	Check points														
Room temperature thermistor (TH21) Liquid pipe temperature thermistor (TH22) Gas pipe temperature thermistor (TH23 ,24)	Disconnect the connector then measure the resistance with a tester. (At the ambient temperature 10°C - 30°C) <table border="1" style="margin-left: 20px;"> <tr> <td>Normal</td> <td>Abnormal</td> </tr> <tr> <td>4.3kΩ~9.6kΩ</td> <td>Open or short</td> </tr> </table> Refer to the next page for the details.	Normal	Abnormal	4.3kΩ~9.6kΩ	Open or short										
Normal	Abnormal														
4.3kΩ~9.6kΩ	Open or short														
Vane motor (MV)	Measure the resistance between the terminals with a tester. (Coil temperature 20°C) <table border="1" style="margin-left: 20px;"> <tr> <td colspan="4">Normal</td> <td rowspan="2">Abnormal</td> </tr> <tr> <td>①-② Brown-Red</td> <td>①-③ Brown-Orange</td> <td>①-④ Brown-Yellow</td> <td>①-⑤ Brown-Green</td> </tr> <tr> <td colspan="4">250Ω ± 7%</td> <td>Open or short</td> </tr> </table>	Normal				Abnormal	①-② Brown-Red	①-③ Brown-Orange	①-④ Brown-Yellow	①-⑤ Brown-Green	250Ω ± 7%				Open or short
Normal				Abnormal											
①-② Brown-Red	①-③ Brown-Orange	①-④ Brown-Yellow	①-⑤ Brown-Green												
250Ω ± 7%				Open or short											
Fan motor (MF)	Refer to 8-1-3.														
Linear expansion valve (LEV)	Disconnect the connector then measure the resistance valve with a tester. (Coil temperature 20°C) <table border="1" style="margin-left: 20px;"> <tr> <td colspan="4">Normal</td> <td rowspan="2">Abnormal</td> </tr> <tr> <td>(1)-(5) White-Red</td> <td>(2)-(6) Yellow-Brown</td> <td>(3)-(5) Orange-Red</td> <td>(4)-(6) Blue-Brown</td> </tr> <tr> <td colspan="4">200Ω ± 10%</td> <td>Open or short</td> </tr> </table>	Normal				Abnormal	(1)-(5) White-Red	(2)-(6) Yellow-Brown	(3)-(5) Orange-Red	(4)-(6) Blue-Brown	200Ω ± 10%				Open or short
Normal				Abnormal											
(1)-(5) White-Red	(2)-(6) Yellow-Brown	(3)-(5) Orange-Red	(4)-(6) Blue-Brown												
200Ω ± 10%				Open or short											

8-1-1. Thermistor

<Thermistor Characteristic graph>

Thermistor for lower temperature

- Room temperature thermistor (TH21)
- Liquid pipe temperature thermistor (TH22)
- Gas pipe temperature thermistor (TH23) (TH24)

Thermistor $R_0=15k\Omega \pm 3\%$
 Fixed number of $B=3480 \pm 2\%$

$$R_t = 15 \exp \left\{ 3480 \left(\frac{1}{273+t} - \frac{1}{273} \right) \right\}$$

0°C	15kΩ
10°C	9.6kΩ
20°C	6.3kΩ
25°C	5.4kΩ
30°C	4.3kΩ
40°C	3.0kΩ

< Thermistor for lower temperature >

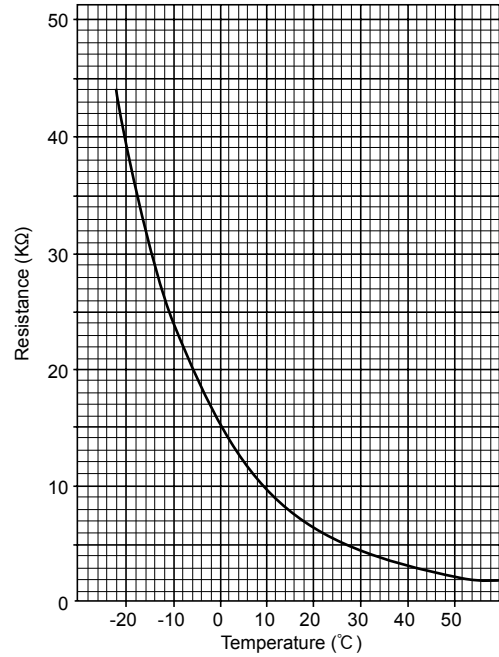

8-1-2. Linear expansion valve

① Operation summary of the linear expansion valve

- Linear expansion valve opens/closes through stepping motor after receiving the pulse signal from the indoor controller board.
- Valve position can be changed in proportion to the number of pulse signal.

<Connection between the indoor controller board and the linear expansion valve>

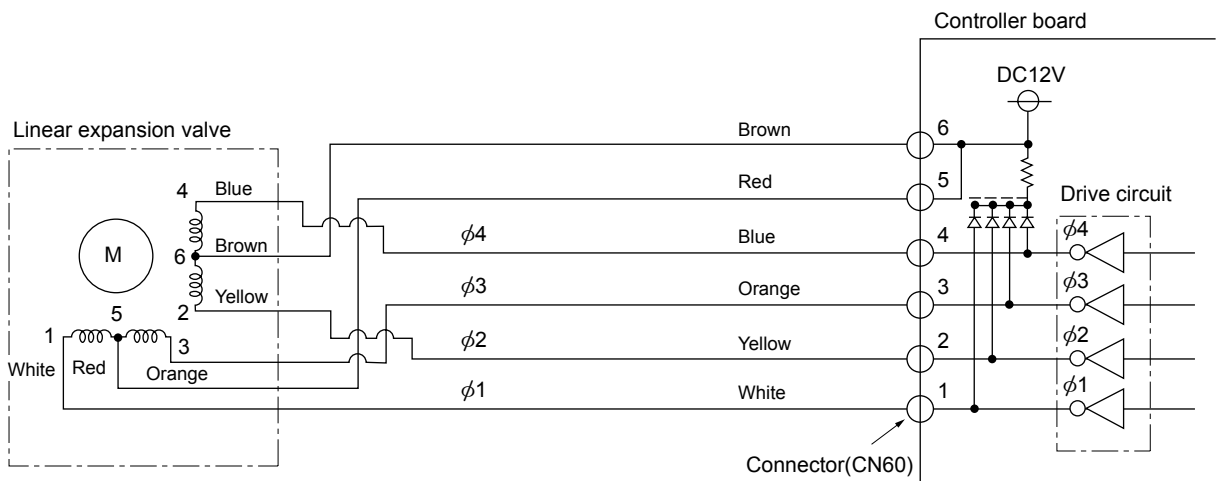

Note : Since the number of the connector at the controller board side and the relay connector are different, follow the color of the lead wire.

<Output pulse signal and the valve operation>

Output (Phase)	Output			
	1	2	3	4
φ1	ON	OFF	OFF	ON
φ2	ON	ON	OFF	OFF
φ3	OFF	ON	ON	OFF
φ4	OFF	OFF	ON	ON

Closing a valve : 1 → 2 → 3 → 4 → 1
 Opening a valve : 4 → 3 → 2 → 1 → 4
 The output pulse shifts in above order.

② Linear expansion valve operation

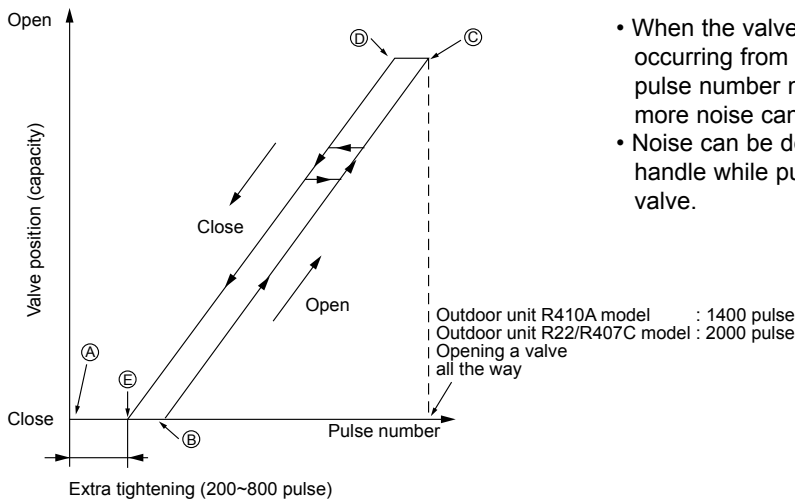

- When linear expansion valve operation stops, all output phase become OFF.
- At phase interruption or when phase does not shift in order, motor does not rotate smoothly and motor will lock and vibrate.
- When the switch is turned on, 2200 pulse closing valve signal will be sent till it goes to point A in order to define the valve position.
- When the valve moves smoothly, there is no noise or vibration occurring from the linear expansion valves : however, when the pulse number moves from E to A or when the valve is locked, more noise can be heard than in a normal situation.
- Noise can be detected by placing the ear against the screw driver handle while putting the screw driver tip to the linear expansion valve.

③ Troubleshooting

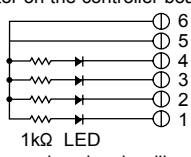
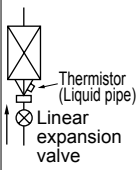
Symptom	Check points	Countermeasures
Operation circuit failure of the micro processor	Disconnect the connector on the controller board, then connect LED for checking.  1kΩ LED When power is turned on, pulse signals will output for 10 seconds. There must be some defects in the operation circuit if the LED does not light while the signals are output or keeps lighting even after the signals stop.	Exchange the indoor controller board in case of drive circuit failure.
Linear expansion valve mechanism is locked.	Motor will idle and make a ticking noise when the motor is operated while the linear expansion valve is locked. This ticking sound is the sign of the abnormality.	Exchange the linear expansion valve.
Short or breakage of the motor coil of the linear expansion valve	Measure the resistance between each coil (white-red, yellow-brown, orange-red, blue-brown) using a tester. It is normal if the resistance is in the range of 200Ω ±10%.	Exchange the linear expansion valve.
Valve does not close completely.	To check the linear expansion valve, operate the indoor unit in fan mode and at the same time operate other indoor units in cooling mode, then check the pipe temperature <liquid pipe temperature> of the indoor unit by the outdoor multi controller board operation monitor. During fan operation, linear expansion valve is closed completely and if there is any leaking, detecting temperature of the thermistor will go lower. If the detected temperature is much lower than the temperature indicated in the remote controller, it means the valve is not closed all the way. It is not necessary to exchange the linear expansion valve, if the leakage is small and not affecting normal operation. 	If large amount of refrigerant is leaked, exchange the linear expansion valve.
Wrong connection of the connector or contact failure	Check the color of lead wire and missing terminal of the connector.	Disconnect the connector at the controller board, then check the continuity.

8-1-3. DC Fan motor (fan motor/indoor controller circuit board)

Check method of DC fan motor (fan motor/indoor controller circuit board)

① Notes

- High voltage is applied to the connector (CNMF) for the fan motor. Pay attention to the service.
- Do not pull out the connector (CNMF) for the motor with the power supply on.
(It causes trouble of the indoor controller circuit board and fan motor.)

② Self check

Symptom : The indoor fan cannot turn around.

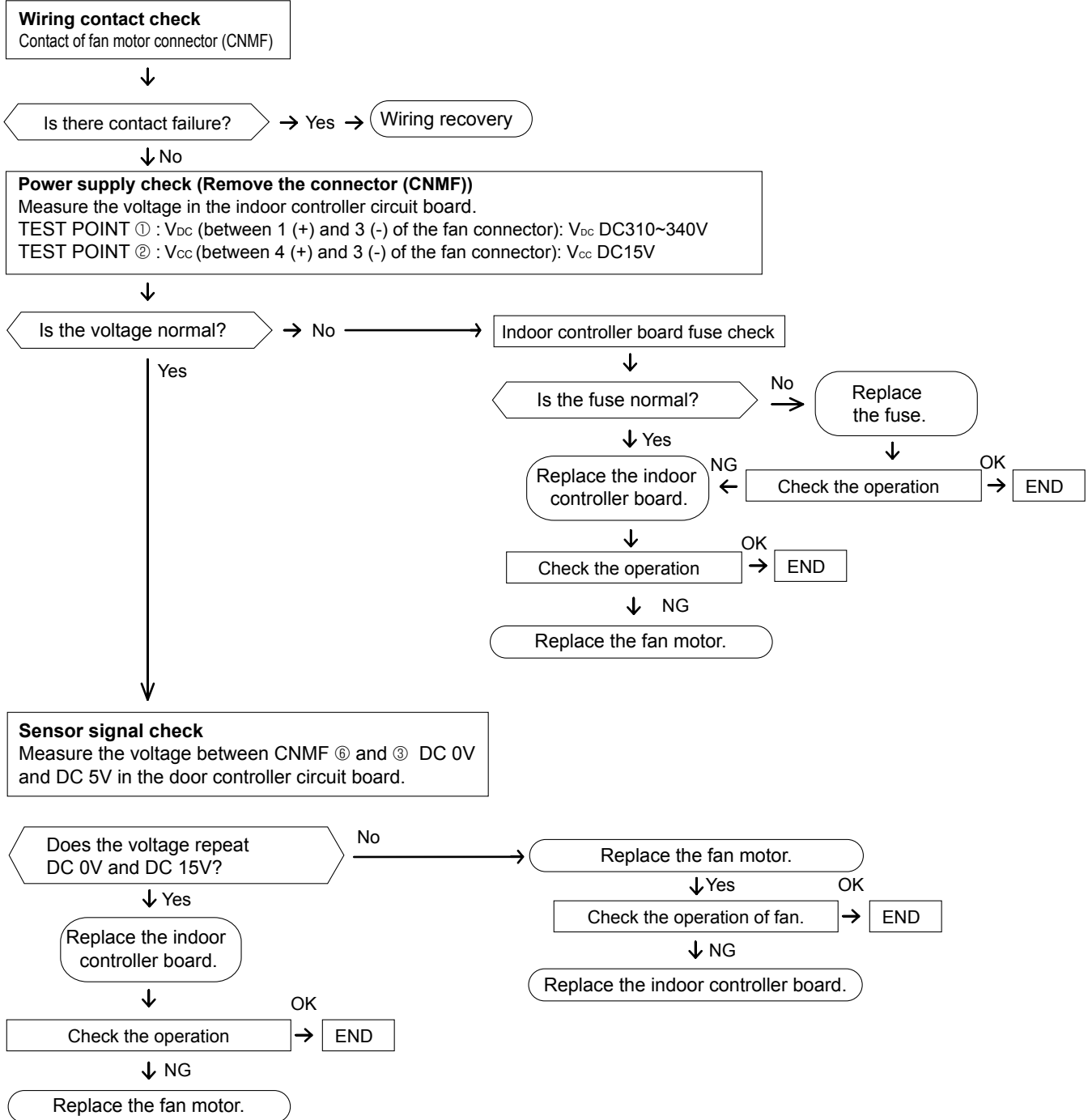

8-2. Function of Dip switch

PKFY-P63VKM-E.TH

PKYF-P100VKM-E.TH

PKFY-P63VKM-ER1.TH

PKFY-P100VKM-ER1.TH

Switch	Pole	Function	Operation by switch		Effective timing	Remarks															
			ON	OFF																	
SW1 Mode selection	1	Thermistor<Room temperature> position	Built-in remote controller	Indoor unit	Under suspension	<div style="border: 1px solid black; padding: 5px; margin-bottom: 5px;">Address board</div> <div style="margin-bottom: 5px;"><Initial setting></div> <div style="margin-bottom: 5px;"> </div> <div style="margin-bottom: 5px;">NOTE: *1</div> <table border="1" style="font-size: small;"> <tr> <td>SW1-7</td> <td>SW1-8</td> <td>Fan speed</td> </tr> <tr> <td>OFF</td> <td>OFF</td> <td>Extra low</td> </tr> <tr> <td>ON</td> <td>OFF</td> <td>Low</td> </tr> <tr> <td>OFF</td> <td>ON</td> <td>Setting air flow</td> </tr> <tr> <td>ON</td> <td>ON</td> <td>Stop</td> </tr> </table> <div style="margin-top: 5px;">*2 It is impossible to intake the fresh air.</div>	SW1-7	SW1-8	Fan speed	OFF	OFF	Extra low	ON	OFF	Low	OFF	ON	Setting air flow	ON	ON	Stop
	SW1-7	SW1-8	Fan speed																		
	OFF	OFF	Extra low																		
	ON	OFF	Low																		
	OFF	ON	Setting air flow																		
	ON	ON	Stop																		
	2	Filter clogging detection	Provided	Not provided																	
	3	Filter cleaning sign	2,500 hr	100 hr																	
	4	Fresh air intake *2	Not effective	Not effective																	
	5	Switching remote controller display	Thermo ON signal indication	Fan output indication																	
6	Humidifier control	Fan operation at Heating mode	Thermo ON operation at heating mode																		
7	Air flow set in case of heat thermo OFF	Low *1	Extra low *1																		
8		Setting air flow *1	Depends on SW1-7																		
9	Auto restart function	Effective	Not effective																		
10	Power ON/OFF by breaker	Effective	Not effective																		
SW2 Capacity code switch	1~6			Before power supply ON	<div style="border: 1px solid black; padding: 5px; margin-bottom: 5px;">Indoor controller board</div> <div style="margin-bottom: 5px;"><Initial setting></div> <div style="margin-bottom: 5px;">Set for each capacity</div>																
SW3 Function selection	1	Heat pump/Cool only	Cooling only	Heat pump	Under suspension	<div style="border: 1px solid black; padding: 5px; margin-bottom: 5px;">Indoor controller board</div> <div style="margin-bottom: 5px;"><Initial setting></div> <div style="margin-bottom: 5px;"> </div> <div style="margin-bottom: 5px;">*1 Second setting is same as first setting.</div> <div style="margin-bottom: 5px;">*2 Please do not change SW3-7 and 3-8.</div>															
	2	Not used	—	—																	
	3	Not used	—	—																	
	4	Vane horizontal angle	Second setting *1	First setting																	
	5	Changing the opening of linear expansion valve during thermo OFF	Effective	Not effective																	
	6	Heating 4 degree up	Not effective	Effective																	
	7	Target superheat setting *2	—	—																	
	8	Target subcool *2	—	—																	
SW4 Model Select	1~4	<div style="margin-bottom: 5px;">ON </div> <div>OFF </div>		Before power supply ON	<div style="border: 1px solid black; padding: 5px; margin-bottom: 5px;">Indoor controller board</div>																
SW11 1s digit address setting SW12 10ths digit address setting	Rotary switch	<div style="display: flex; justify-content: space-around;"> <div style="text-align: center;"> 10 </div> <div style="text-align: center;"> 1 </div> </div> <p>How to set addresses Example : If address is "3", remain SW12 (for over 10) at "0", and match SW11 (for 1 to 9) with "3".</p>		Before power supply ON	<div style="border: 1px solid black; padding: 5px; margin-bottom: 5px;">Address board</div> <div style="margin-bottom: 5px;"><Initial setting></div> <div style="display: flex; justify-content: space-around;"> <div style="text-align: center;"> SW12 </div> <div style="text-align: center;"> SW11 </div> </div>																
SW14 Branch No. Setting	Rotary switch	<div style="text-align: center;"> SW14 </div> <p>How to set branch numbers SW14 (Series R2 only) Match the indoor unit's refrigerant pipe with the BC controller's end connection number. Remain other than series R2 at "0".</p>			<div style="border: 1px solid black; padding: 5px; margin-bottom: 5px;">Address board</div> <div style="margin-bottom: 5px;"><Initial setting></div> <div style="text-align: center;"> SW14 </div>																

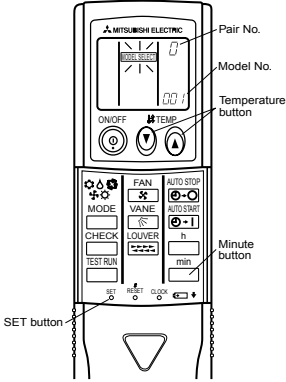

Switch	Operation by switch	Effective timing	Remarks																											
J41, J42 Wireless remote controller Pair No.	<p style="text-align: center;">Jumper</p> <ul style="list-style-type: none"> To operate each indoor unit by each remote controller when installed 2 indoor units or more are near, Pair No. setting is necessary. <ul style="list-style-type: none"> Pair No. setting is available with the 4 patterns (Setting patterns A to D). Make setting for J41, J42 of indoor controller board and the Pair No. of wireless remote controller. You may not set it when operating it by one remote controller. <ul style="list-style-type: none"> Setting for indoor unit Cut jumper wire J41, J42 on the indoor controller board according to the table below. Wireless remote controller pair number: Setting operation <ol style="list-style-type: none"> Press the SET button (using a pointed implement). Check that the remote controller's display has stopped before continuing. MODEL SELECT flashes, and the model No. (3 digits) appears (steadily-lit). Press the MINUTE button twice. The pair number appears flashing. Press the temperature (M) (A) buttons to select the pair number to set. Press the SET button (using a pointed implement). The set pair number is displayed (steadily-lit) for 3 seconds, then disappears. <table border="1" data-bbox="284 797 963 999"> <thead> <tr> <th rowspan="2">Setting pattern</th> <th colspan="2">Indoor controller jumper wire</th> <th rowspan="2">Pair No. of wireless remote controller*</th> <th rowspan="2"></th> </tr> <tr> <th>J41</th> <th>J42</th> </tr> </thead> <tbody> <tr> <td>A</td> <td>—</td> <td>—</td> <td>0</td> <td>Initial setting</td> </tr> <tr> <td>B</td> <td>Cut</td> <td>—</td> <td>1</td> <td>—</td> </tr> <tr> <td>C</td> <td>—</td> <td>Cut</td> <td>2</td> <td>—</td> </tr> <tr> <td>D</td> <td>Cut</td> <td>Cut</td> <td>3</td> <td>—</td> </tr> </tbody> </table> <p>* Pair No. 4-9 of wireless remote controller is setting pattern D.</p>	Setting pattern	Indoor controller jumper wire		Pair No. of wireless remote controller*		J41	J42	A	—	—	0	Initial setting	B	Cut	—	1	—	C	—	Cut	2	—	D	Cut	Cut	3	—	Under operation or suspension	<p style="text-align: center;"><Initial setting> Pattern A</p> 
Setting pattern	Indoor controller jumper wire		Pair No. of wireless remote controller*																											
	J41	J42																												
A	—	—	0	Initial setting																										
B	Cut	—	1	—																										
C	—	Cut	2	—																										
D	Cut	Cut	3	—																										

8-3. TEST POINT DIAGRAM

8-3-1. Indoor controller board

PKFY-P63VKM-E.TH
 PKFY-P63VKM-ER1.TH
 PKFY-P100VKM-E.TH
 PKFY-P100VKM-ER1.TH

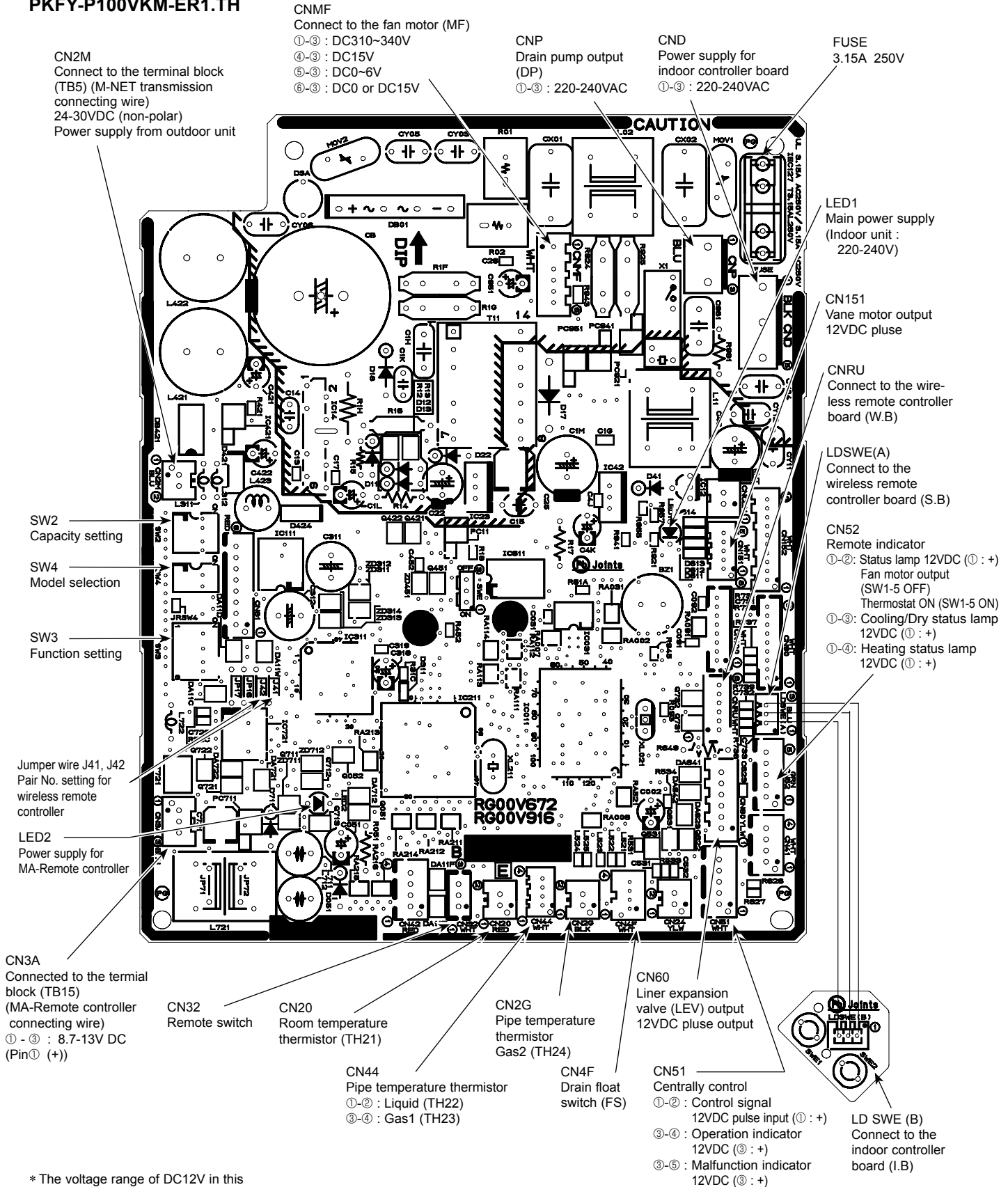

* The voltage range of DC12V in this page is between DC11.5 V to DC 13.7 V.

8-3-2. Wireless remote controller board

PKFY-P63VKM-E.TH
 PKFY-P63VKM-ER1.TH
 PKFY-P100VKM-E.TH
 PKFY-P100VKM-ER1.TH

LD101
 Connect to the
 indoor controller
 board (I.B)

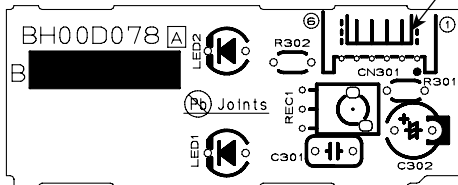

8-3-3. Address board

PKFY-P63VKM-E.TH
 PKFY-P63VKM-ER1.TH
 PKFY-P100VKM-E.TH
 PKFY-P100VKM-ER1.TH

SW1
 Function setting

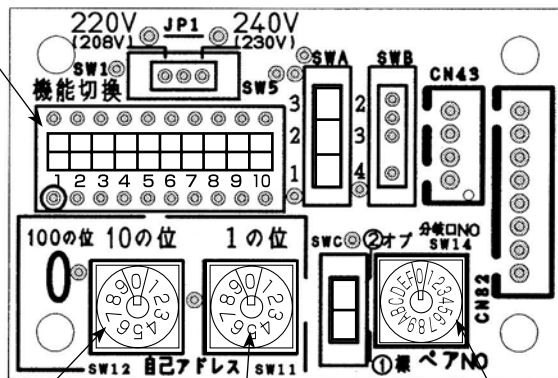

SW12
 Address setting
 10ths DIGIT

SW11
 Address setting
 1s DIGIT

SW14
 Branch No.

PKFY-P63VKM-E.TH
PKFY-P63VKM-ER1.TH

PKFY-P100VKM-E.TH
PKFY-P100VKM-ER1.TH

Be careful when removing heavy parts.

OPERATION PROCEDURE

1. REMOVING THE PANEL

- (1) Press and unlock the knobs on both sides of the front grille and lift the front grille until it is level. Pull the hinges forward to remove the front grille. (See Photo 1)
- (2) Remove 3 screw caps of the panel. Remove 5 screws. (See Photo 1)
- (3) Unfix 3 hooks. (See Figure 1)
- (4) Hold the lower part of both ends of the panel and pull it slightly toward you, and then remove the panel by pushing it upward.
- (5) Remove the screw of the corner box. (See Photo 1)
Remove the corner box.

PHOTOS & ILLUSTRATIONS

Photo 1

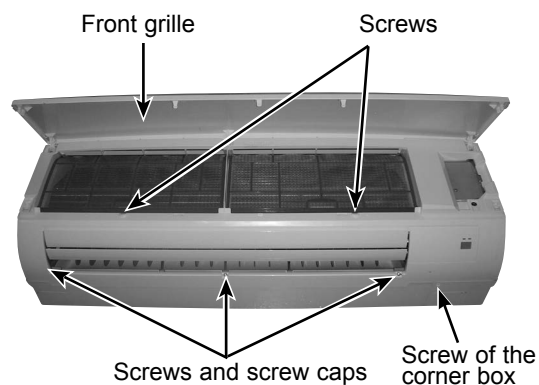
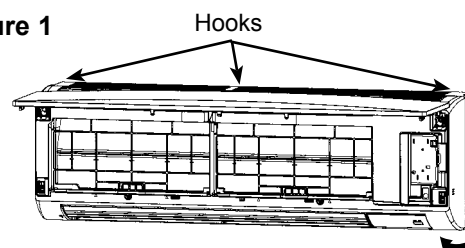

Figure 1



2. REMOVING THE ADDRESS BOARD, THE INDOOR CONTROLLER BOARD, THE WIRELESS CONTROLLER BOARD

- (1) Remove the panel and the corner box. (Refer to procedure 1)
- (2) Remove the screw and hook of address board case. (See Photo 2)
- (3) Disconnect the connectors of address board.
- (4) Remove the front and side electrical box covers (each 1 screw).
- (5) Disconnect the connectors on the indoor controller board. (See Photo 3)
- (6) Remove the switch board holder and open the cover.
- (7) Pull out the indoor controller board toward you then remove the indoor controller board and switch board. (See Photo 3)
- (8) Remove the holder of wireless remote controller board.
- (9) Disconnect the connector of wireless remote controller board and remove the wireless remote controller board from the holder.

Photo 2

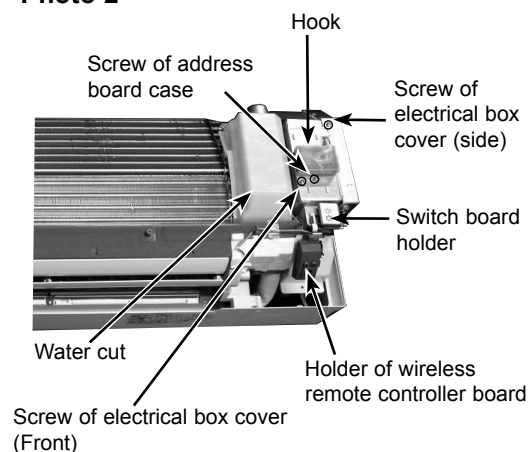
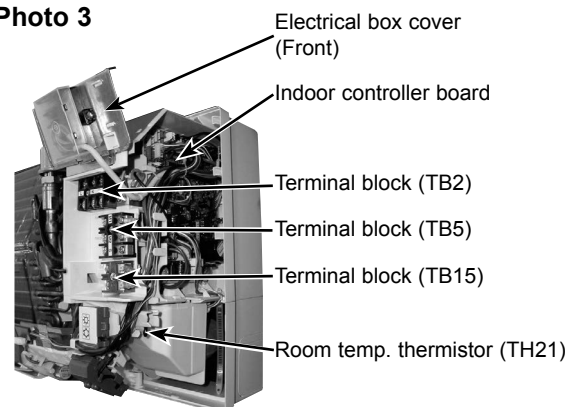

Photo 3



OPERATION PROCEDURE

3. REMOVING THE ELECTRICAL BOX

- (1) Remove the panel and the corner box. (Refer procedure to 1)
- (2) Remove the screw and hook of address board case.
- (3) Remove the front and side electrical box covers (each 1 screw).
- (4) Remove the transmission wiring of TB5, the power supply wiring of TB2 and the wiring of MA-remote controller (TB15).
- (5) Disconnect the connectors on the indoor controller board.
- (6) Disconnect the connector for ground wire.
- (7) Remove the screw on lower side of the electrical box. (See Photo 5)
- (8) Push up the upper fixture catch to remove the box, then remove it from the box fixture.

PHOTOS

Photo 4

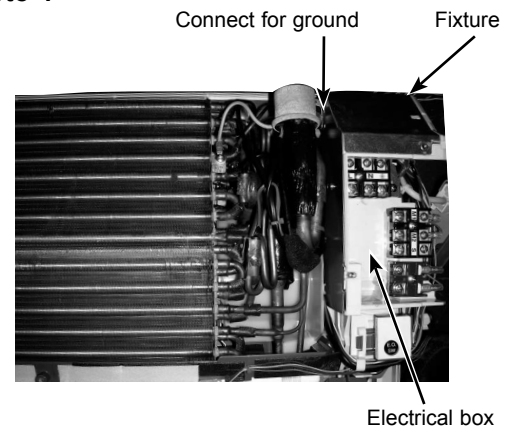

4. REMOVING THE NOZZLE ASSEMBLY (with VANE and VANE MOTOR) AND DRAIN HOSE

- (1) Remove the panel and corner box. (Refer to procedure 1)
- (2) Remove the electrical box covers. (Refer to procedure 2)
- (3) Disconnect the vane motor connector (CN151) on the indoor controller board.
- (4) Pull out the drain hose from the nozzle assembly, and remove nozzle assembly. (See Photo 5)

Photo 5 (see the bottom)

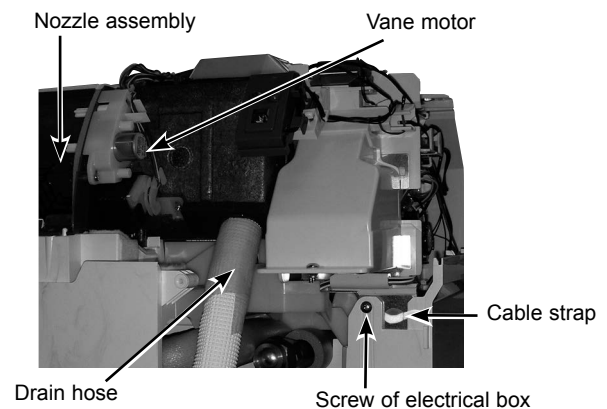

5. REMOVING THE VANE MOTOR

- (1) Remove the nozzle assembly. (Refer to procedure 4)
- (2) Remove 2 screws of the vane motor unit cover, and pull out the vane motor unit.
- (3) Remove 2 screws of the vane motor unit.
- (4) Remove the vane motor from the vane motor unit.
- (5) Disconnect the connector from the vane motor.

Photo 6

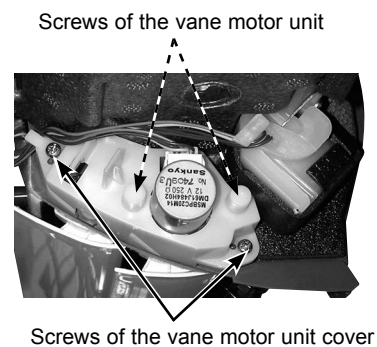

OPERATION PROCEDURE

6. REMOVING THE INDOOR FAN MOTOR AND THE LINE FLOW FAN

- (1) Remove the panel and the corner box. (Refer to procedure 1)
- (2) Remove the electrical box (Refer to procedure 2) and the nozzle assembly (Refer to procedure 4).
- (3) Remove the water cut. (See Photo 2)
- (4) Remove the screw fixing the line flow fan. (See Photo 8)
- (5) Remove 5 screws fixing the motor bed. (See Photo 7)
- (6) Remove the lead wire of pipe thermistor from the hook of motor bed. (See Photo 7)
- (7) Remove the screw fixing motor band. (See Photo 7)
- (8) Remove the motor bed together with fan motor and motor band.
- (9) Remove 3 screws fixing the left side of the heat exchanger. (See Photo 9)
- (10) Lift the heat exchanger, and pull out the line flow fan to the lower-left.

Photo 9

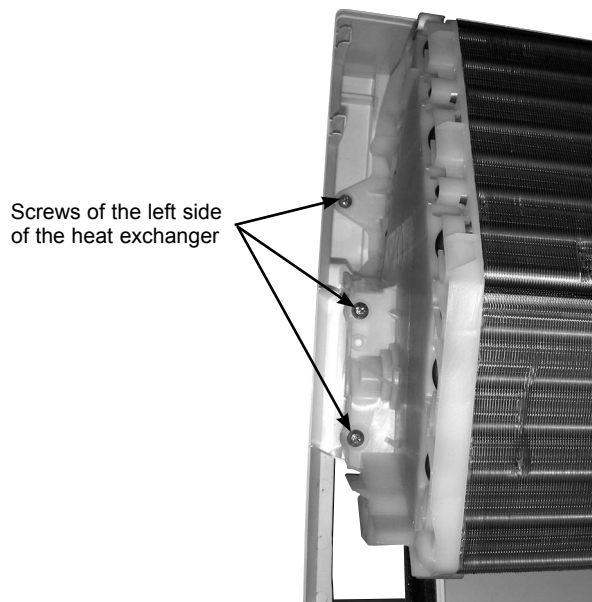

PHOTOS

Photo 7

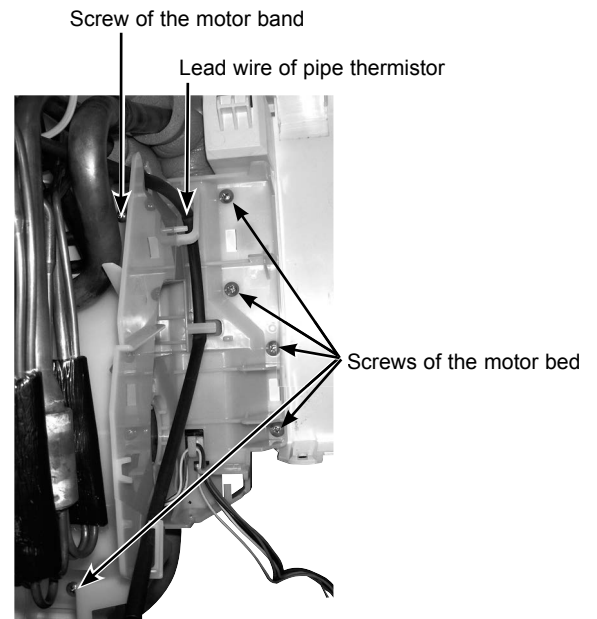
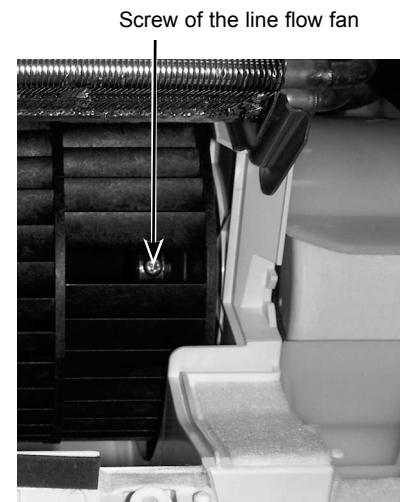

Photo 8



7. REMOVING THE LIQUID PIPE THERMISTOR AND GAS PIPE THERMISTOR

- (1) Remove the panel and the corner box. (Refer to procedure 1)
- (2) Remove the electrical box covers. (Refer to procedure 2)
- (3) Remove the water cut. (See Photo 2)
- (4) Remove the liquid pipe thermistor and gas pipe thermistors.
- (5) Disconnect the connector (CN44) (CN2G) on the indoor controller board. (TH22 and TH23/CN44, TH24/CN2G)

Photo 10

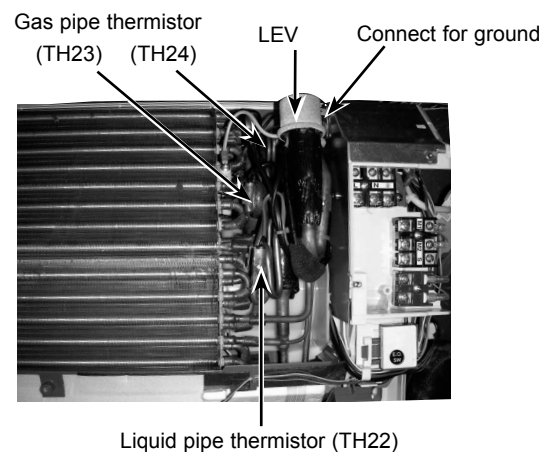

OPERATION PROCEDURE

8. REMOVING THE HEAT EXCHANGER AND LEV

- (1) Remove the panel and the corner box. (Refer to procedure 1)
- (2) Remove the electrical box (Refer to procedure 3) and the nozzle assembly (Refer to procedure 4).
- (3) Remove the water cut.
- (4) Remove the pipe thermistors (Refer to 7.).
- (5) Disconnect the connector (CN60) on the indoor controller board and the connector for ground wire.
- (6) Remove 3 screws fixing the left side of the heat exchanger. (See Photo 9)
- (7) Remove the heat exchanger with LEV.

PHOTOS

Photo 11

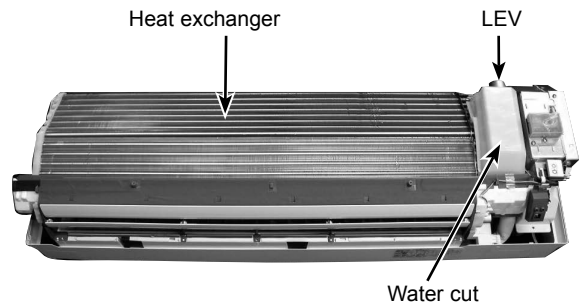
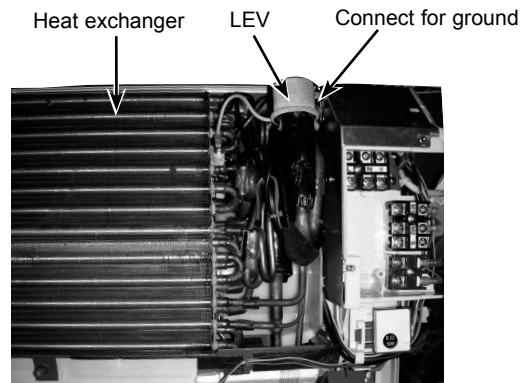

Photo 12



9. REMOVING THE ROOM TEMPERATURE THERMISTOR

- (1) Remove the panel and corner box. (Refer to procedure 1)
- (2) Remove the electrical box covers. (Refer to procedure 2)
- (3) Remove the room temperature thermistor.
- (4) Disconnect the connector (CN20) on the indoor controller board.

Photo 13

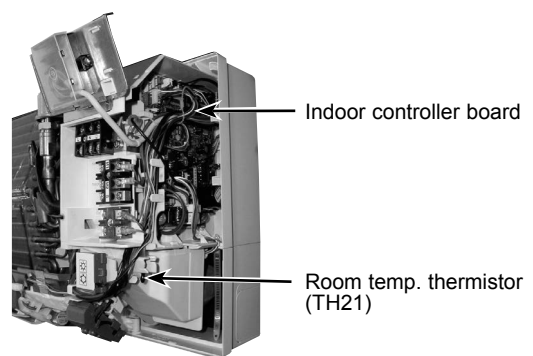

MITSUBISHI ELECTRIC CORPORATION

HEAD OFFICE : TOKYO BLDG., 2-7-3, MARUNOUCHI, CHIYODA-KU TOKYO 100-8310, JAPAN